

Unit 1. Antennas and Free Space Propagation

ECE-GY 6023. INTRODUCTION TO WIRELESS COMMUNICATIONS

PROF. SUNDEEP RANGAN



Learning Objectives

- Mathematically describe an EM wave:
 - Direction of motion, wavenumber, frequency, polarization, ...
- Identify radio spectrum and power levels used in common commercial wireless products
- Perform basic power calculations in dB scale
- Perform basic mathematical operations in polar coordinates
 - Conversions to cartesian coordinates, rotations, integrals, averages, ...
- Use tools from MATLAB to compute and plot key antenna parameters
 - Directivity, gain, efficiency, ...
- Compute received power in an angular region using the radiation density and intensity.
- Compute the free-space path loss using Friis Law
- Derive Friis Law

Outline

-  Basics of Electromagnetic Waves
 - Power and Bandwidth of Signals
 - Basics of Antennas
 - Free Space Propagation

Electric and Magnetic Forces

- Two closely related forces:
 - **Electric**: Forces between charged particles
 - **Magnetic**: Forces between moving charged particles
- EM forces operate at a distance
 - Current in one location \Rightarrow current in another location
- Enables **communication**
 - Modulate current at a TX
 - Currents create EM fields in space
 - Detect modulation at a RX

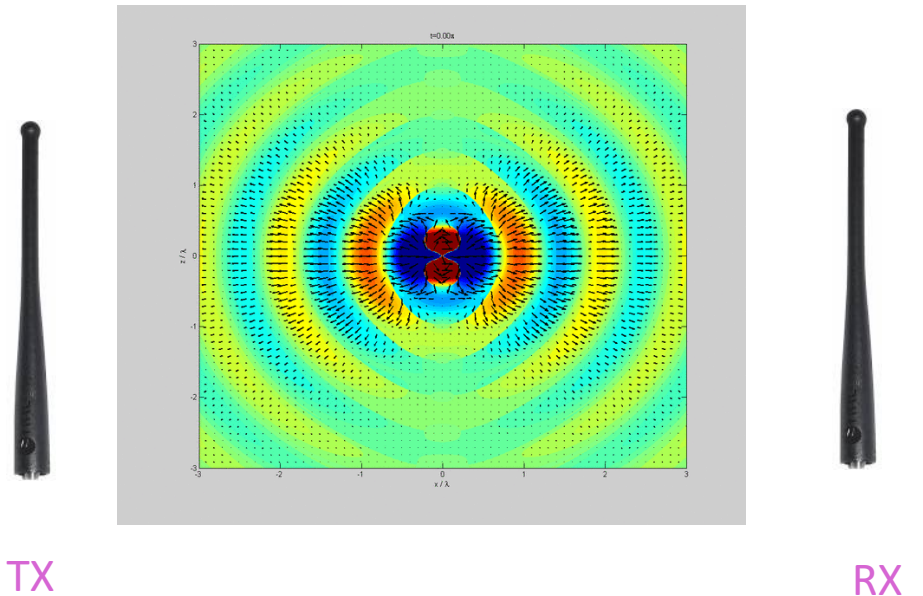

Electric and Magnetic Vector Fields

- E and M forces represented by a **vector field**
 - Changes with position $\mathbf{r} = (x, y, z)$ and time t
 - Force strength has a direction and magnitude

- **Electric Field:** $\mathbf{E}(\mathbf{r}, t)$
 - Units: N/C (force / unit charge)

- **Magnetic field:** $\mathbf{B}(\mathbf{r}, t)$
 - Units: in N/(Am) = Teslas (force / unit charge / velocity)

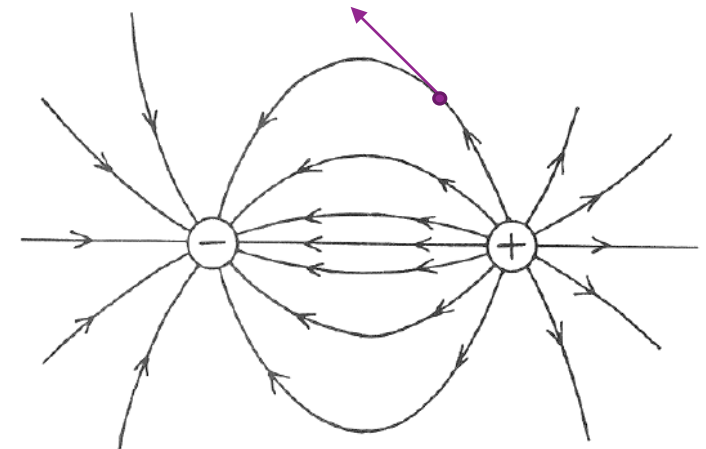
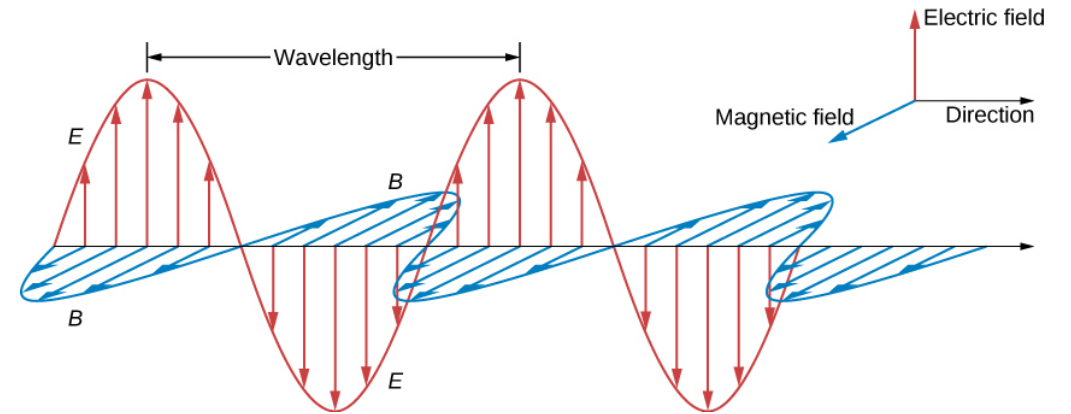

FIGURE 2.4 Electric field lines begin and end on charges.

Plane Waves

- EM field governed by Maxwell's equations
- In free space, all solutions can be decomposed into plane waves
- EM plane wave at position $\mathbf{r} = (x, y, z)$
 - $\mathbf{E}(\mathbf{r}, t) = E_0 \mathbf{e}_y \cos(2\pi(ft + \lambda^{-1}x) + \phi)$
 - $\mathbf{B}(\mathbf{r}, t) = B_0 \mathbf{e}_z \cos(2\pi(ft + \lambda^{-1}x) + \phi)$
- Key constraints:
 - $\mathbf{E}(\mathbf{r}, t)$ is always perpendicular to $\mathbf{B}(\mathbf{r}, t)$
 - $B_0 = (1/c)E_0$
 - $c = \lambda f = \text{speed of light}$



Visualizing Plane Waves

□ EM plane wave at position $\mathbf{r} = (x, y, z)$

- $\mathbf{E}(\mathbf{r}, t) = E_0 \mathbf{e}_y \cos(2\pi(ft + \lambda^{-1}z) + \phi)$
- $\mathbf{B}(\mathbf{r}, t) = B_0 \mathbf{e}_z \cos(2\pi(ft + \lambda^{-1}z) + \phi)$

□ At any given position \mathbf{r} :

- E and B fields vary sinusoidally with frequency f
- Maximum amplitudes E_0 and B_0
- Phase ϕ

□ For a fixed time t , along direction x

- E and B fields vary sinusoidally with wavelength $\lambda = \frac{c}{f}$

□ Can be viewed as traveling along direction

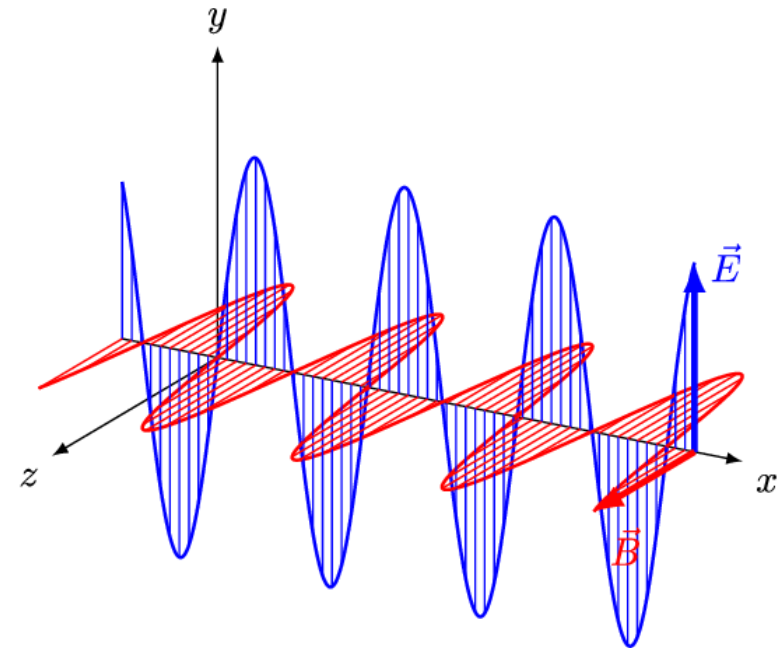

Plane Wave Direction of Motion

□ Direction of motion = direction of “energy flux”

□ “Poynting” vector:

$$\mathbf{S} = \frac{1}{\mu} \mathbf{E} \times \mathbf{B} = \frac{|E_0|^2}{c\mu} \cos^2(2\pi(ft - \lambda^{-1}z)) \mathbf{e}_x$$

- \mathbf{e}_x = direction of motion
- Represents “energy flux”
- Energy consumed = $\nabla \cdot \mathbf{S}$
- Units = W/m^2
- $\eta = c\mu$ = characteristic impedance
- Vacuum: $\eta = \eta_0 \approx 377\Omega$

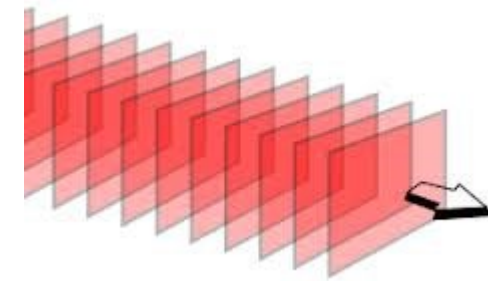
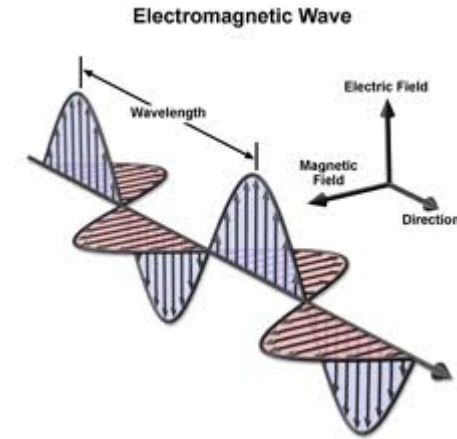

Polarization

□ **Polarization**: Orientation of E-field relative to direction of motion

□ **Linearly polarized**: Constant orientation

- Vertical: $\mathbf{E}(\mathbf{r}, t) = E_0 \mathbf{e}_x \cos(\omega t + kz)$
- Horizontal: $\mathbf{E}(\mathbf{r}, t) = E_0 \mathbf{e}_y \cos(\omega t + kz)$
- **Angular frequency** $\omega = 2\pi f$ and **wave number** $k = \frac{2\pi}{\lambda}$

□ **Two degrees of freedom**:

- Consider any plane wave in some direction
- Can be decomposed as V + H

□ Also, **circularly polarized**

- Sum of V and H that are out of phase
- $E_0[\mathbf{e}_x \cos(\omega t + kz) \pm \mathbf{e}_y \sin(\omega t + kz)]$
- Called left hand and right hand

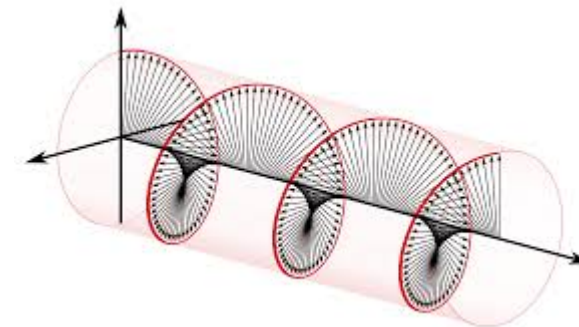

Plane Wave Decomposition

- Every electric field is a linear combination of plane waves
- Each plane wave in the decomposition has:
 - Frequency
 - Direction of motion
 - Gain, Phase
 - One of two polarization
- Decomposition can be found from a 4D Fourier transform
 - $\mathbf{E}(x, y, z, t) \Rightarrow \hat{E}_V(k_x, k_y, k_z, f)$ and $\hat{E}_H(k_x, k_y, k_z, f)$
 - Converts time + space \Rightarrow wavenumber and frequency
 - Note that there are two polarization components
- This decomposition is used in many EM solvers
 - And your EM class if you take it

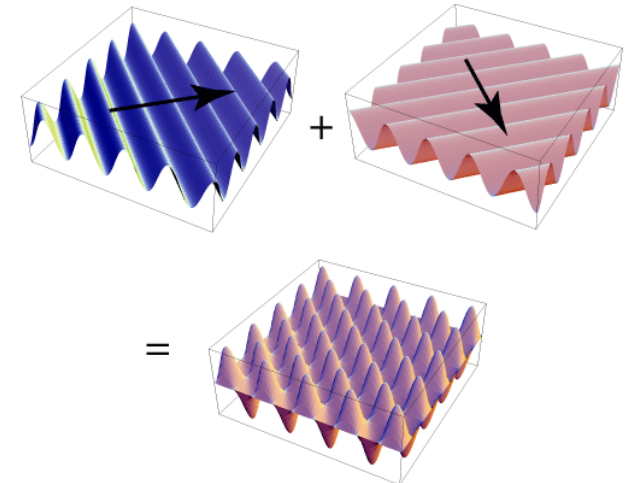

In-Class Problem

Problem 1

Suppose that an EM-plane wave:

- Power flux density is 1 nW/m^2
- Freq = 2.3 GHz

Print the:

- Maximum E-field value
- Wavelength. You may use the `physconst('Lightspeed')` command to get the speed of light.

Make sure you print the units.

Outline

Basics of Electromagnetic Waves

 Power and Bandwidth of Signals

Basics of Antennas

Free Space Propagation

Signals for Communication



- ❑ **Signal:** Any quantity that varies in time
 - Continuous, discrete, complex, real, ...
- ❑ **Signals for wireless communications:**
 - Modulate an information bearing signal to a signal in the EM radiation
- ❑ **Three key characteristics of the signal:** power, bandwidth, center frequency

Energy and Power of Signals

- ❑ Consider a scalar-valued, continuous-time signal $x(t)$
- ❑ Define **instantaneous power**: $|x(t)|^2$
- ❑ Typically $|x(t)|^2$ this is proportional to the actual power
 - Ex 1: For a voltage, power = $\frac{|V(t)|^2}{R}$
 - Ex 2: For an EM plane wave, power flux = $\frac{|E(t)|^2}{\eta}$
- ❑ **Energy**:
 - $E_x = \int_{-\infty}^{\infty} |x(t)|^2 dt$
 - Signal is called an “energy signal” if $E_x < \infty$
- ❑ **Power**:
 - $P_x = \lim_{T \rightarrow \infty} \frac{1}{T} \int_{-T/2}^{T/2} |x(t)|^2 dt$
 - Energy per unit time
 - Signal is called a “power signal” if limit P_x exists and is finite

Power: Linear and Decibel scale

□ Linear scale units

- Power measured in Watts (W) or mW
- Power values in W or mW called *linear scale*
- Energy measured in Joules (J) or mJ

□ Power often measured in dB scale:

- $P_{\text{dBW}} = 10\log_{10}(P_{\text{W}} / 1\text{W})$
- $P_{\text{dBm}} = 10\log_{10}(P_{\text{mW}} / 1\text{mW})$
- $E_{\text{dBmJ}} = 10\log_{10}(E_{\text{mJ}} / 1\text{mJ})$
- dB scale is preferred since wireless signals have very large range

□ Example: $P = 250 \text{ mW}$ (typical max mobile transmit power)

- In dBW: $P = 10\log_{10}(0.25\text{W} / 1\text{W}) = -6 \text{ dBW}$
- In dBm: $P = 10\log_{10}(250\text{mW} / 1\text{mW}) = 24 \text{ dBm}$

Some important dB values

□ Some conversions don't need a calculator:

- $10\log_{10}(2) = 3$ [Most important: Doubling power = 3dB]
- $10\log_{10}(3) = 4.7 \sim 5$
- $10\log_{10}(10) = 10$

□ You can cascade these.

□ Ex: What is 50 mW in dBm?

□ Ans:

$$\begin{aligned} 10 \log_{10}(50) &= 10 \log_{10}(10^2/2) \\ &= (2)10 \log_{10}(10) - 10 \log_{10}(2) = 2(10) - 3 = 17 \text{ dBm} \end{aligned}$$



Gain and Loss in dB

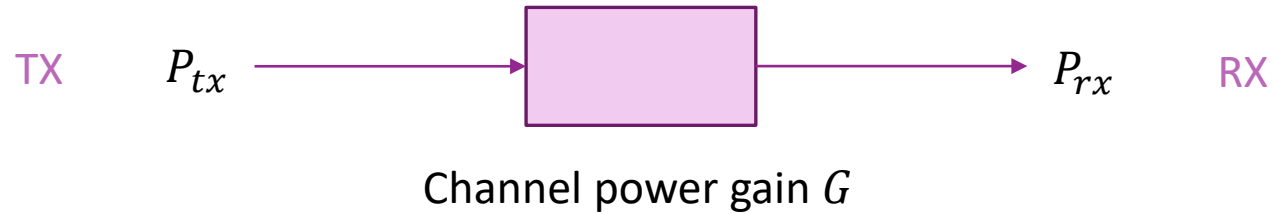

Linear scale: Gain is multiplication

$$P_{rx} = GP_{tx}$$

- P_{tx} , P_{rx} : TX and RX power in W or mW
- G : Power gain (dimensionless)
- $G > 1$: Gain (e.g. amplifier)
- $G < 1$: Loss (e.g. propagation, attenuator, ...)

dB scale: : Gain is addition

$$P_{rx} = G + P_{tx}$$

- P_{tx} , P_{rx} : TX and RX power in dBW or dBm
- G : Power gain in dB
- $G > 0$: Gain
- $G < 0$: Loss

Typical Wireless Power Transmit Levels

- ❑ 100 kW = 80 dBm: Typical FM radio transmission with 50 km radius
- ❑ 1 kW = 60 dBm: Microwave oven element (most of this doesn't escape)
- ❑ ~300 W = 55 dBm: Geostationary satellite
- ❑ 250 mW = 24 dBm: Cellular phone maximum power (class 2)
- ❑ 200 mW = 23 dBm: WiFi access point
- ❑ 32 mW = 15 dBm: WiFi transmitter in a laptop
- ❑ 4 mW = 6 dBm: Bluetooth 10 m range
- ❑ 1 mW = 0 dBm: Bluetooth, 1 m range

Example: Power and Time Calculation

- **Problem:** Suppose that: TX power= 17 dBm, path loss= 80 dB
- What is the RX power in dBm and mW?
 - dB scale: $P_{rx} = P_{tx} - PL = 17 - 80 = -63$ dBm
 - Linear scale: $-63 = -60 - 3 \Rightarrow P_{rx} = (0.5)10^{-6}$ mW = 0.5 nW
- What is the energy received in $T = 4$ us (Symbol time for an 802.11g OFDM system):
 - Linear scale: $E_{rx} = P_{rx}T = (0.5)10^{-6}4(10)^{-6} = 2(10)^{-12}$ mJ
 - dB Scale: Converting $2(10)^{-12}$ mJ to dB: $E_{rx} = -120 + 3 = -117$ dBmJ
- Note unit: dBmJ = Energy relative to 1 mJ
- Can also compute the energy directly without converting to linear scale:
 - $E_{rx} = P_{rx} + 10 \log_{10}(T) = P_{tx} - PL + 10 \log_{10}(T) = 17 - 80 + 6 - 60 = -117$ dBmJ

Bandwidth and Carrier Frequency

❑ Power density spectrum:

- PSD measures the power per unit frequency
- Indicates range of frequencies of the corresponding EM wave
- Measured by a spectrum analyzer

❑ Two key parameters for RF signals:

- Carrier or center frequency, $f = f_c$
- Bandwidth W

❑ Note for a real-valued signal: Always two images

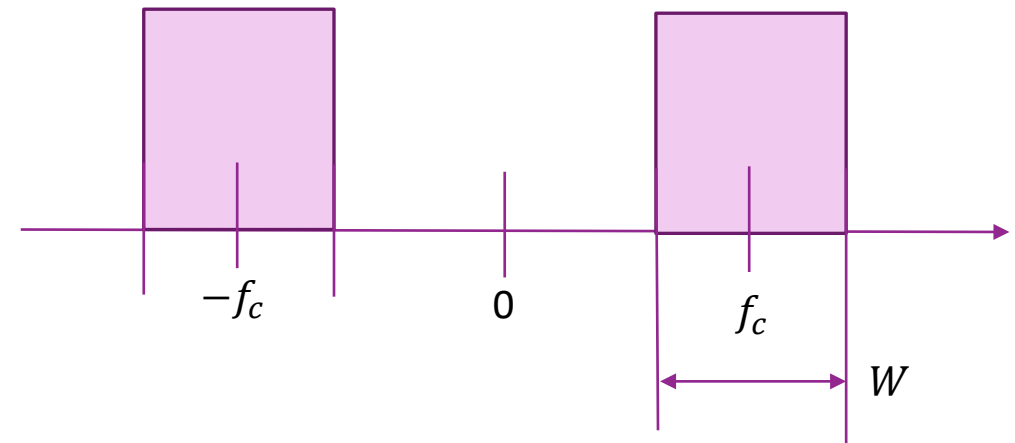

Example: PSD Calculation

- **Problem:** Suppose that: TX power= 17 dBm, path loss= 80 dB, bandwidth = 16.25 MHz
 - Assume power is transmitted uniformly over the bandwidth
 - Bandwidth is the occupied BW for an 802.11g signal

- What is the RX power in dBm in a 5 MHz bandwidth:

- In linear scale, RX PSD = $S = \frac{P_{rx}}{W_{tot}}$, $W_{tot} = 16.25$ MHz
- RX power in $W_0 = 5$ MHz is $P_0 = SW_0 = \frac{P_{rx}W_0}{W_{tot}}$

- In dB scale:

$$\begin{aligned} P_0 &= P_{rx} + 10 \log_{10} \left(\frac{W_0}{W_{tot}} \right) = P_{tx} - PL + 10 \log_{10} \left(\frac{W_0}{W_{tot}} \right) \\ &= 17 - 80 + 10 \log_{10} \left(\frac{5}{16.25} \right) = -68.1 \text{ dBm} \end{aligned}$$

Importance of Bandwidth

- Data rate generally scales linearly in bandwidth
 - If the transmit power and bandwidth increase by $N \Rightarrow$ the communication rate increase by N
 - We will see this in detail later
- Ex: Compare GSM (2G) and LTE (4G)
 - Single channel of GSM system = 200 kHz
 - Single channel of LTE = 20 MHz
 - If power scales sufficiently, LTE would in general have 100x data rate
 - LTE, in fact, can have even more capacity due to other improvements
- Figure to the right: 802.11ad channels
 - The channels are > 2 GHz

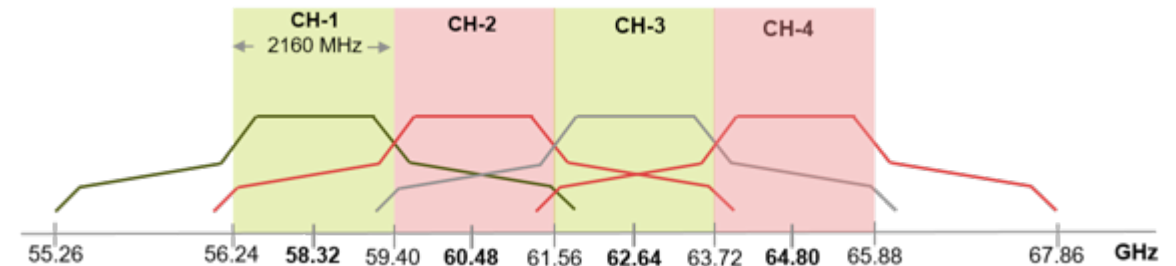

Radio Spectrum

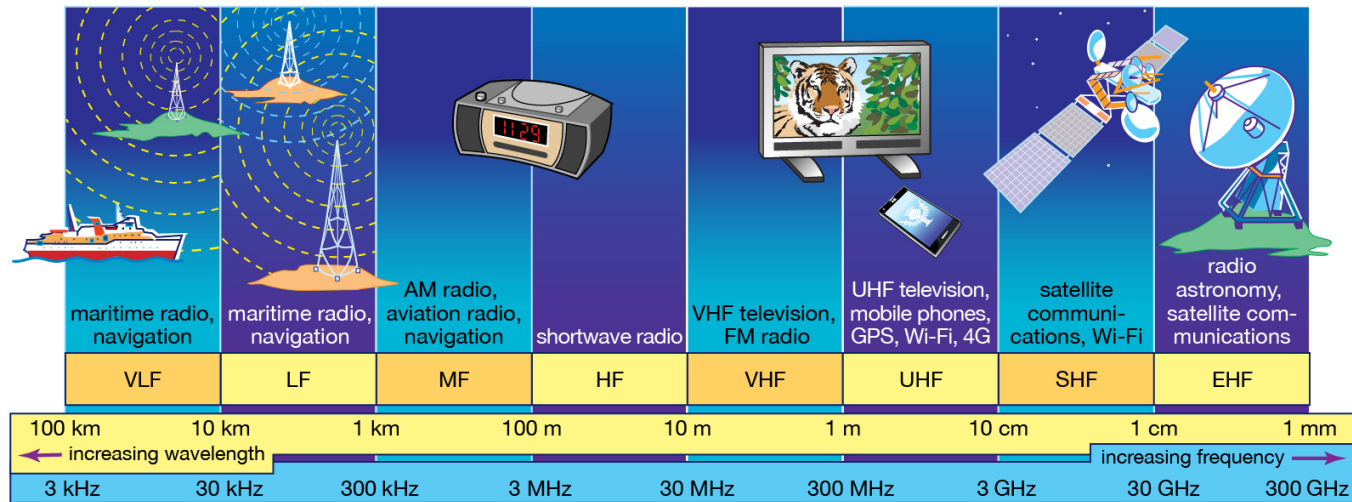

© 2013 Encyclopaedia Britannica, Inc.

Less bandwidth
Greater Range

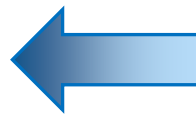

More bandwidth
Less Range

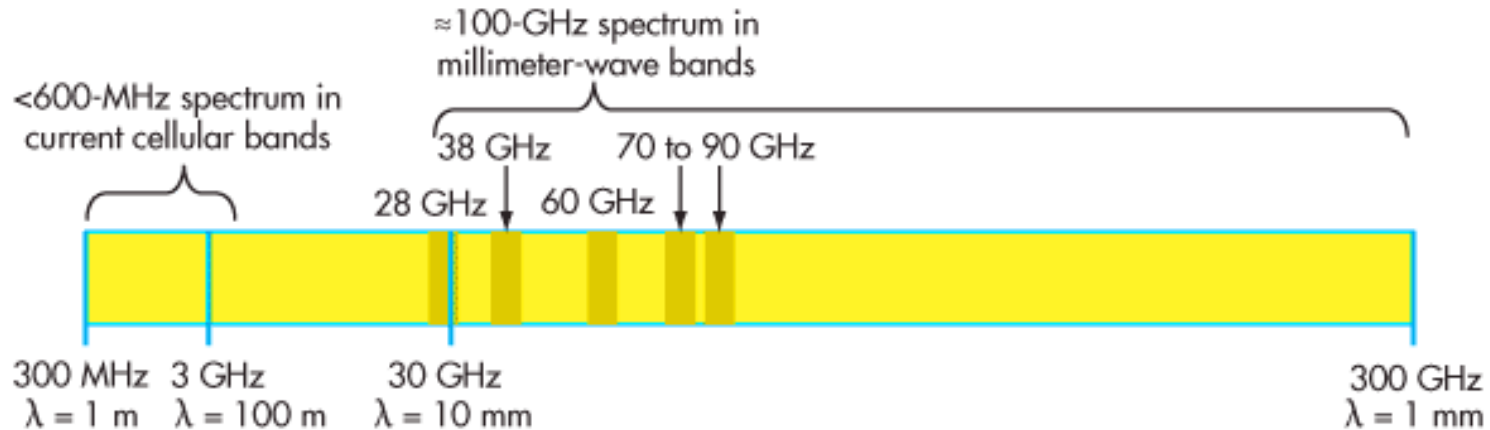

Image: Britanica, <https://www.britannica.com/science/radio-frequency-spectrum>



Millimeter Wave Bands

- New bands for 5G
 - 100x more bandwidth than conventional bands below 6 GHz
 - Bands at 28 GHz and 38 GHz opened up by FCC
 - 5G systems operating have just started deployments



In-Class Exercise

Problem 2: Computing Power in a LTE PSS

In an LTE system, each base station (called eNB in 3GPP terminology) periodically transmits a Primary Synchronization Signal (PSS) so that mobiles can detect a mobile (called a UE or user equipment) can detect the base station. The PSS occupies:

- In frequency: 72 sub-carriers at 15 kHz per sub-carrier
- In time: One OFDM symbol = 2048 samples at 30.72 Ms/s

The following diagram shows the transmission of the OFDM:

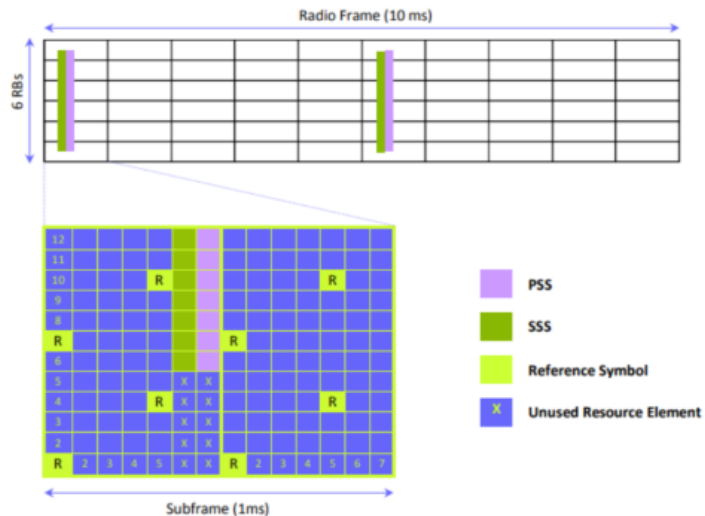

Suppose the eNB has a total transmit power of 43 dBm uniformly over 20 MHz. The path loss between the eNB and UE is 100 dB. What is the received energy per PSS? Print your answer in dBmJ.

Outline

Basics of Electromagnetic Waves

Power and Bandwidth of Signals

 Basics of Antennas

Free Space Propagation

Excellent Text for Antennas

- ❑ This lecture is based on classic text
 - Balanis, “Antenna Theory”
 - Most of the figures here are from this text
- ❑ If you want to learn more, study the text:
 - Provides full EM theory view
 - Many excellent problems and examples
 - Designed for RF engineers

- ❑ We will use only a small portion here
- ❑ Take an EM class for more!

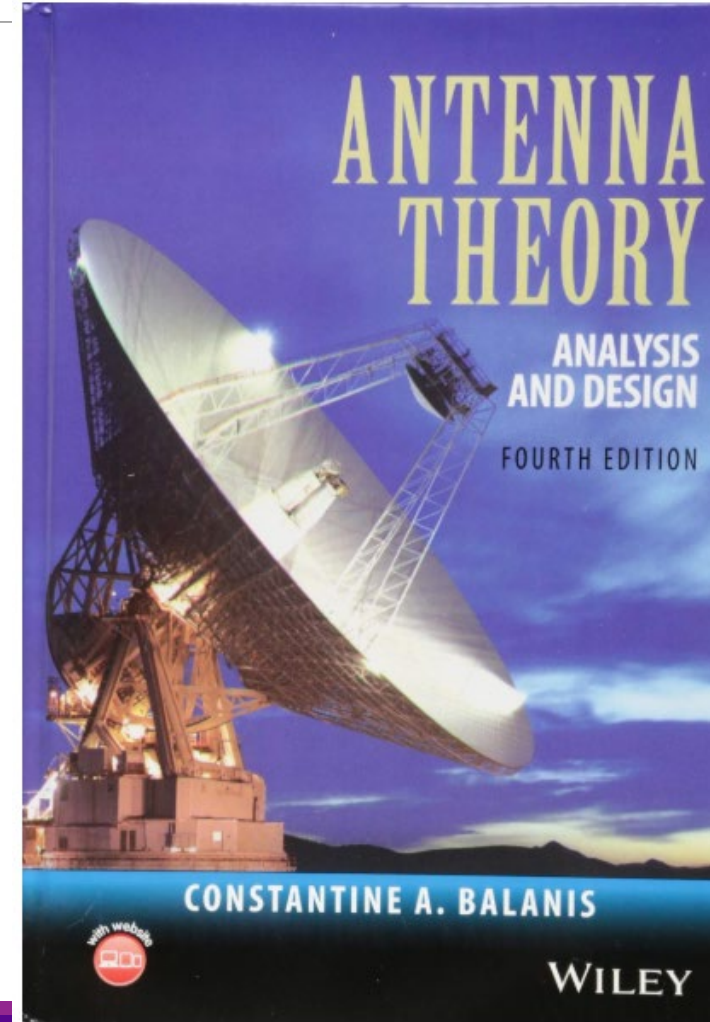

Waveguides and Transmission Lines

- **Transmission lines** and **waveguides**: Any structure to guide waves with minimal loss
- Some texts:
 - Transmission lines refer to conductors and waveguides to hollow structures
- Many examples



Coaxial cable

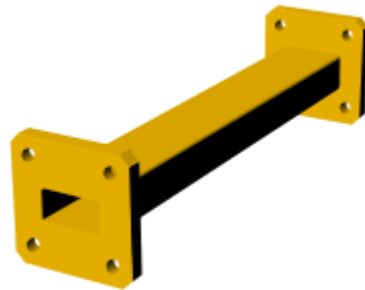

Waveguide

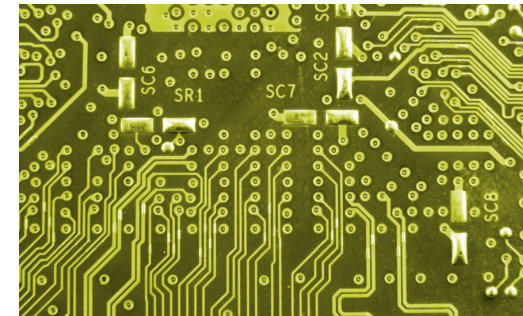

PCB traces

Microstrip: External layer

Stripline: Internal layer



Antenna

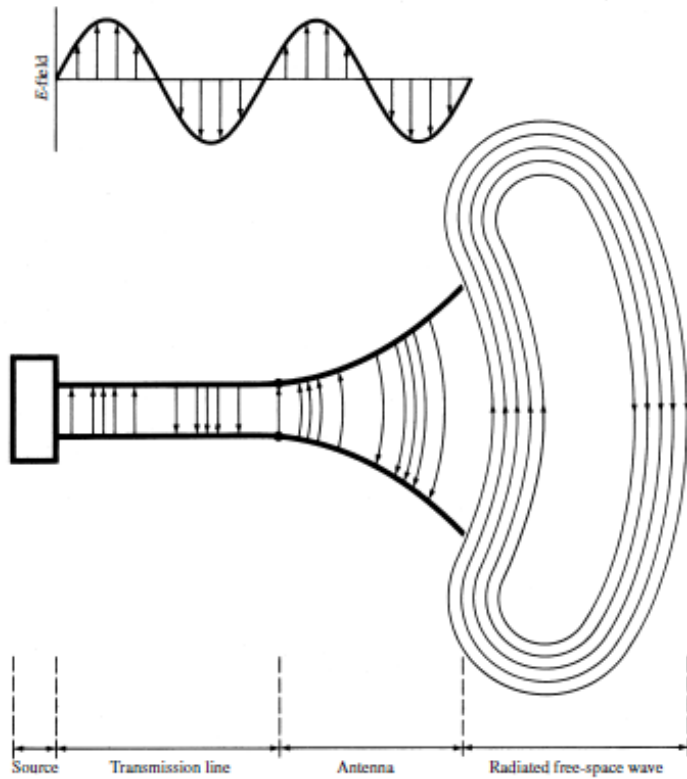

Figure 1.1 Antenna as a transition device.

- ❑ Transmit antenna: Radiates electromagnetic waves
- ❑ Converts signals:
 - From guided signals in transmission lines to
 - To radiation in free space
- ❑ Receive antenna: Collects EM wave



USRP with four vertical antennas

Radiation Patterns

□ Antenna radiation typically shown via a **pattern**

- Value of **scalar** as a function of **position**
- Antenna usually at origin
- Orientation of the antenna is important

□ Many possible quantities:

- Power, electric field, ...
- Normalized or un-normalized
- Can be 2D or 3D

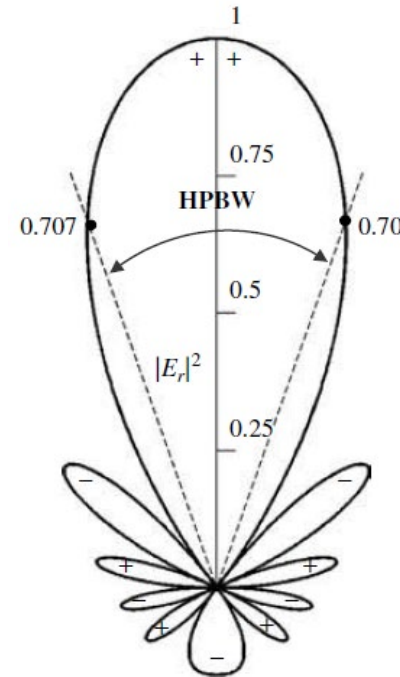

2D

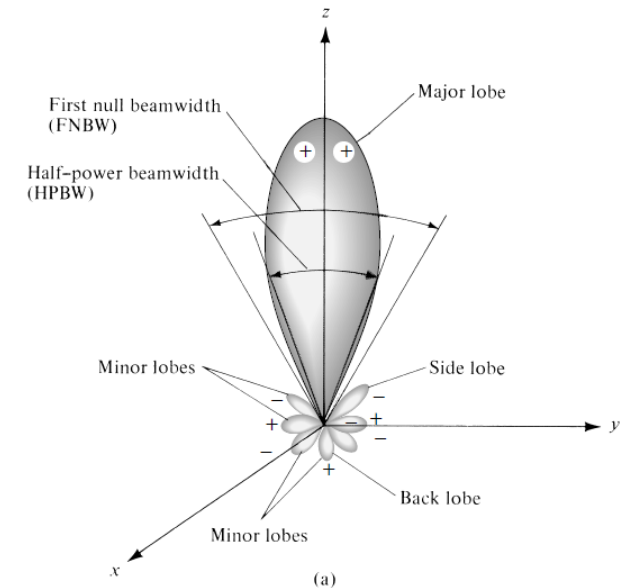

3D

Spherical Coordinates

❑ Radiation patterns are often given in spherical coordinates

❑ **Polar coordinates:** (φ, θ, r)

- $\varphi \in [-\pi, \pi]$: **Azimuth**, counter-clockwise angle in xy plane
- $\theta = \theta_{inc} \in [0, \pi]$: **Inclination** angle from z axis
- $r \geq 0$: **Radius** from origin

❑ Wireless sometimes uses **elevation form:** $(\varphi, \theta_{el}, r)$

- Use $\theta_{el} = \frac{\pi}{2} - \theta_{inc} \in [\frac{\pi}{2}, \frac{\pi}{2}]$
- Measures angle from xy-plane
- Most antenna and math texts use polar form
- But MATLAB antenna toolbox uses elevation form

❑ Remember right hand rule!

Polar coordinates

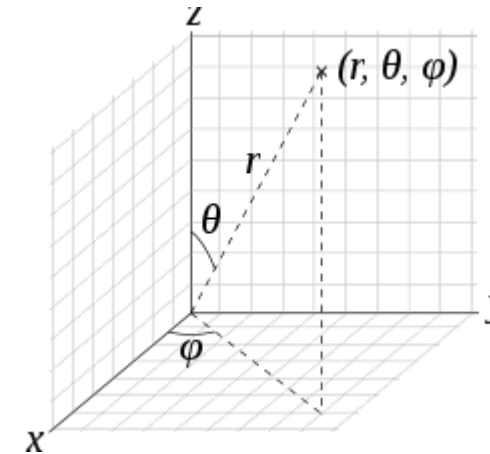

Spherical (polar form) \Leftrightarrow Cartesian

$$\begin{aligned} r &= \sqrt{x^2 + y^2 + z^2}, & x &= r \sin \theta \cos \varphi, \\ \varphi &= \arctan \frac{y}{x}, & y &= r \sin \theta \sin \varphi, \\ \theta &= \arccos \frac{z}{\sqrt{x^2 + y^2 + z^2}}, & z &= r \cos \theta. \end{aligned}$$

Spherical Coordinates in MATLAB

□ Conversion between spherical and cartesian

```
% Generate four random points in 3D
X = randn(3,4);

% Compute spherical coordinates of a matrix of points
% Note these are in radians!
[az, el, rad] = cart2sph(X(1,:), X(2,:), X(3,:));

% Convert back
[x,y,z] = sph2cart(az,el,rad);
Xhat = [x; y; z];
```

```
x = r .* cos(elevation) .* cos(azimuth)
y = r .* cos(elevation) .* sin(azimuth)
z = r .* sin(elevation)
```

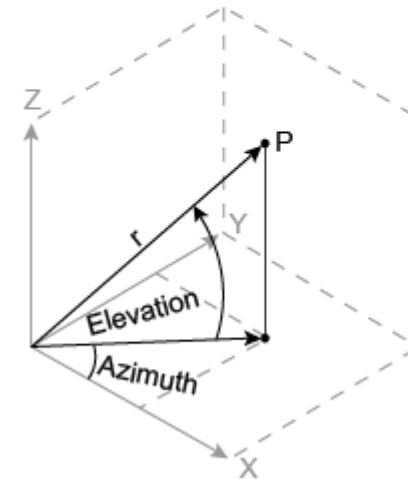

□ Conversion to a coordinate system

```
%% Conversion to a new frame of reference

% Angles of new frame of reference
% Note these are in degrees!
az1 = 0;
el1 = 45;

% Rotate to the new frame of reference
% This takes row vectors!
X1 = cart2sphvec(X,az1,el1);
```

Radians and Steradians

□ Radian:

- Circle of radius one
- Angle for unit length on circumference
- 2π radians in the circle

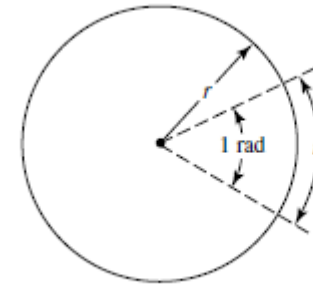

(a) Radian

□ Steradian

- Defined on sphere of radius one
- Angles corresponding to unit area on surface
- 4π sr in the sphere

□ Infinitesimal area and solid angle:

$$dA = r^2 \sin \theta d\theta d\phi \quad (\text{m}^2) \quad d\Omega = \frac{dA}{r^2} = \sin \theta d\theta d\phi \quad (\text{sr})$$

- Note: θ is the inclination angle not elevation

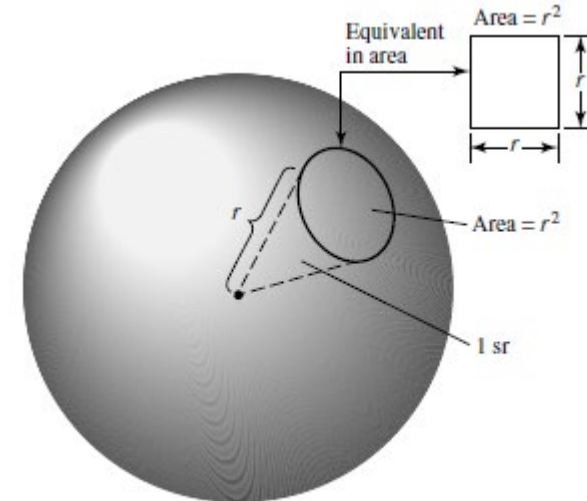

(b) Steradian

Radiation Density

- Recall instantaneous energy flux for a plane wave: $\mathbf{S}(t) = \frac{1}{\mu} \mathbf{E}(t) \times \mathbf{B}(t) = \frac{1}{\eta} \|\mathbf{E}(t)\|^2 \mathbf{n}$
 - \mathbf{n} = normal vector in direction of the plane wave, $\eta = c\mu$ = characteristic impedance
- Typically consider fields at some frequency $\omega = 2\pi f$: $\mathbf{E}(t) = \text{Re}[\mathbf{E}e^{i\omega t}]$
- Time average power $\langle \mathbf{S}(t) \rangle = \frac{1}{2\eta} \|\mathbf{E}\|^2 \mathbf{n}$
 - Note factor of 2
- Can write $\langle \mathbf{S}(t) \rangle = W \mathbf{n}$, $W = \frac{1}{2\eta} \|\mathbf{E}\|^2$
 - **Radiation density**: $W = W(r, \theta, \phi) = \frac{1}{2\eta} |E(r, \theta, \phi)|^2 =$ radiation density
 - Maximum power available if aligned in the direction \mathbf{n}
 - Units W/m^2
 - This is a function of position $W(r, \theta, \phi)$

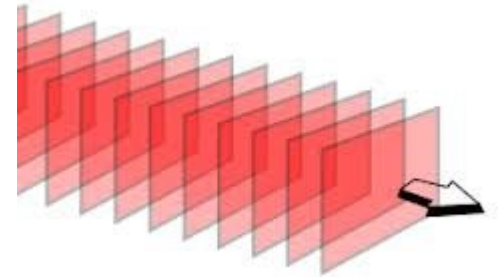

Radiation Intensity

□ From previous slide: **Radiation density**: $W = W(r, \theta, \phi) = \frac{1}{2\eta} |\mathbf{E}(r, \theta, \phi)|^2$

◦ Units $\frac{W}{m^2}$

□ Also define **radiation intensity**: $U = r^2 W = \frac{r^2}{2\eta} |\mathbf{E}(r, \theta, \phi)|^2$

◦ Watts per solid angle: $\frac{W}{sr}$

□ In far field, radiation pattern typically decays as:

◦ $\mathbf{E}(r, \theta, \phi) \approx \frac{1}{r} \mathbf{E}_0(\theta, \phi)$

◦ In this case, $U(r, \theta, \phi) = r^2 W(r, \theta, \phi) = \frac{r^2}{2\eta} |\mathbf{E}(r, \theta, \phi)|^2 \approx \frac{1}{2\eta} |\mathbf{E}_0(\theta, \phi)|^2$

◦ Only depends on angular position $U(r, \theta, \phi) = U(\theta, \phi)$

◦ Does not depend on distance r

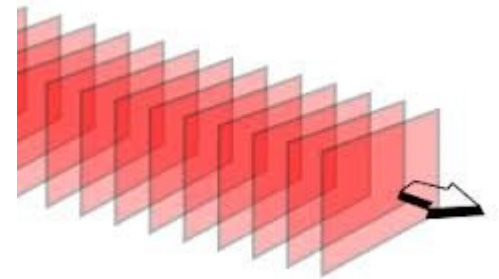

Total Radiated Power

□ Total radiated power:

$$P_{rad} = \iint U d\Omega = \int_{-\pi/2}^{\pi/2} \int_{-\pi}^{\pi} U(\theta, \phi) \cos \theta d\phi d\theta$$

- Units is Watts
- Note $\cos \theta$ term! Angle here is elevation angle not polar angle

□ Typically measured in dBm or dBW:

- $P_{rad}[\text{dBm}] = 10 \log_{10} \left[\frac{P_{rad}}{1 \text{ mW}} \right], P_{rad}[\text{dBW}] = 10 \log_{10} \left[\frac{P_{rad}}{1 \text{ W}} \right]$
- Power relative to mW or W



Example Problem

□ **Problem:** Total radiated power: $P_{rad} = 30$ dBm

- Assume power is uniformly radiated
- At distance of 2 km, what is the power that strikes a 1 cm x 2 cm surface?

□ **Solution:**

- Since power is uniform, radiation density is $W = \frac{P_{tx}}{4\pi d^2}$
- RX power in small area is $P_{rx} = AW = \frac{AP_{tx}}{4\pi d^2}$
- Area in m^2 , $A = 2(10)^{-4} m^2$
- In dB scale:

$$P_{rx} = P_{tx} + 10 \log_{10} \left(\frac{A}{4\pi d^2} \right) = 30 + 10 \log_{10} \left(\frac{2(10)^{-4}}{4\pi(2000)^2} \right) = -84 \text{ dBm}$$

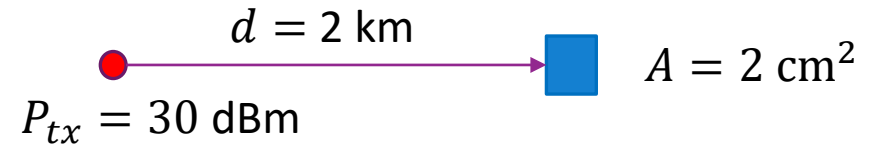

Isotropic Antenna

- ❑ **Isotropic antenna:** Radiates uniformly in all directions
- ❑ Radiation density and intensity are uniform
 - Radiation density: $W(\theta, \phi, r^2) = \frac{P_{rad}}{4\pi r^2}$
 - Radiation intensity: $U(\theta, \phi) = \frac{P_{rad}}{4\pi}$
 - Do not depend on angles θ, ϕ
- ❑ Mostly theoretical construct:
 - Most real antennas have some “directivity”
- ❑ In fact, there can be no coherent (linearly polarized) isotropic radiator
 - E-field would be always tangent to sphere
 - Such an E-field would have to go to zero in at least one point (“Hairy Ball Theorem”)

Theoretical isotropic pattern

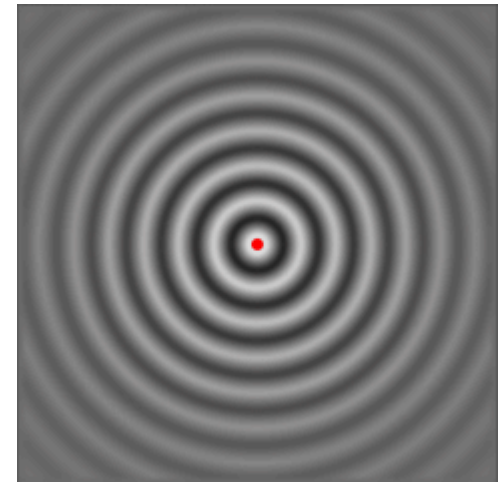

Antenna Directivity

- ❑ Most real antennas concentrate power in certain angles
 - They are non-isotropic
- ❑ Antenna directivity:
 - $D(\theta, \phi) = \frac{4\pi U(\theta, \phi)}{P_{rad}}$ [dimensionless]
 - Measures power at an angle relative to average
 - Average in linear domain is one
 - For isotropic antenna, $D(\theta, \phi) = 1$
- ❑ Max directivity: $D_{max} = \max D(\theta, \phi)$
 - Directivity in direction with maximum power
- ❑ Typically measured in dBi
 - dB relative to isotropic
 - $D(\theta, \phi) [dBi] = 10 \log \left[\frac{4\pi U(\theta, \phi)}{P_{rad}} \right]$

Theoretical isotropic antenna

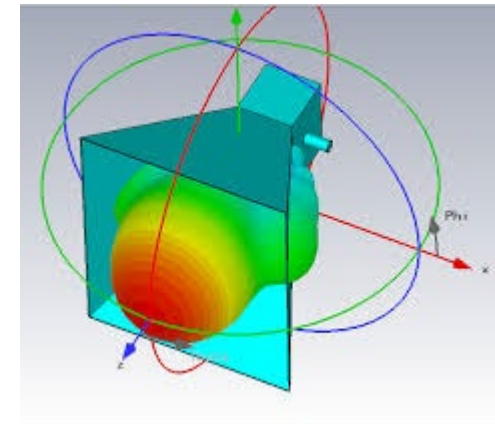
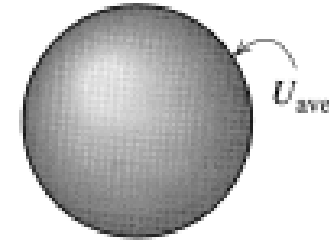

Horn antenna with directivity

Antenna Gain and Efficiency

❑ Most antennas have losses

❑ Define **efficiency**:

$$\epsilon = \frac{P_{rad}}{P_{in}} \in [0,1]$$

- Radiated to input power in TX mode
- Remaining power is lost in heat in the antenna
- Losses in the conductor and dielectric

❑ Lossless antenna: $\epsilon = 1$

❑ **Antenna gain**:

- $G(\theta, \phi) = \epsilon D(\theta, \phi) = \frac{4\pi U(\theta, \phi)}{P_{in}}$
- Radiation intensity per unit input power
- For losses antennas, gain = directivity

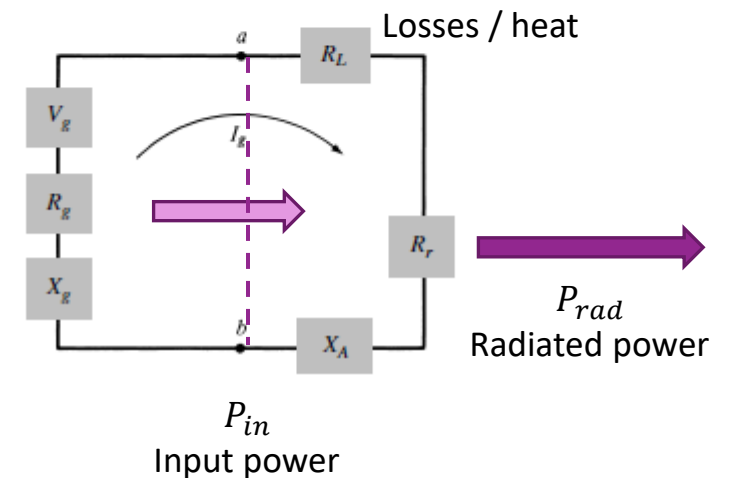
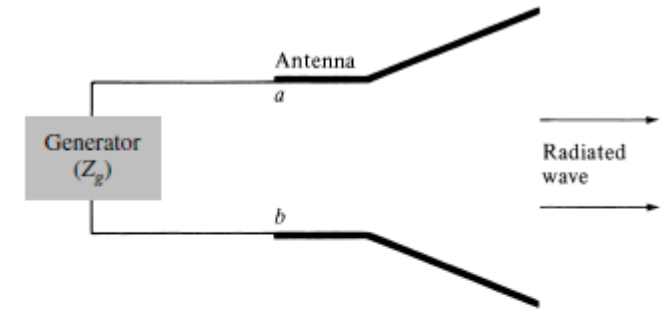

Antenna Toolbox in MATLAB

- ❑ Powerful routines for:
 - Design and analysis of antennas
- ❑ Benefits:
 - Supports many antennas
 - Accurate EM modeling
 - Nice visualization tools
 - Simple to use
- ❑ Also, free to NYU students
 - Just download it with MATLAB
- ❑ But...very slow for complex antennas

Antenna Toolbox

Design, analyze, and visualize antenna elements and antenna arrays

Antenna Toolbox™ provides functions and apps for the design, analysis, and visualization of antennas using either predefined elements with parameterized geometry or arbitrary shapes.

Antenna Toolbox uses the method of moments (MoM) to compute port properties such as the near-field and far-field radiation pattern. You can visualize antenna radiation patterns and radiation patterns.

You can integrate antennas and arrays into wireless systems and use impedance matching, beam forming and beam steering algorithms. Gerber files can be generated from large platforms such as cars or airplanes and analyze the effects of the structure using a variety of propagation models.

Get Started

Learn the basics of Antenna Toolbox

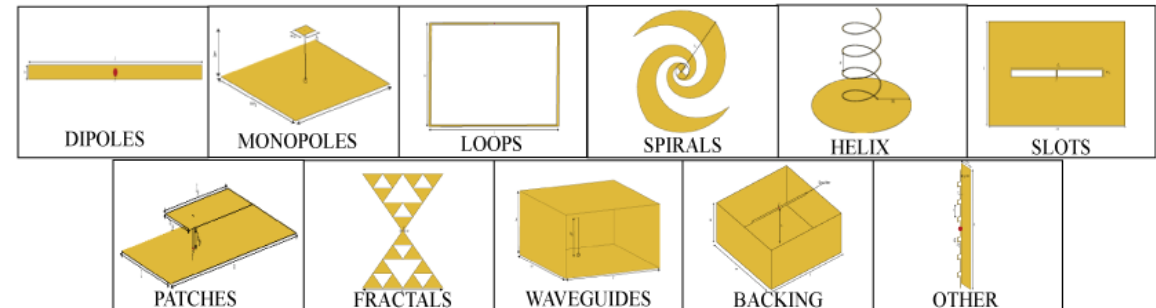

Patterns in MATLAB: Dipole Example

- MATLAB has powerful tools for calculating antenna patterns

```
%% Simulation constants
fc = 28e9;
vp = physconst('lightspeed');
lambda = vp/fc;

%% Dipole antenna
% Construct the antenna object
ant = dipole(...
    'Length', lambda/2,...
    'Width', 0.01*lambda );
```

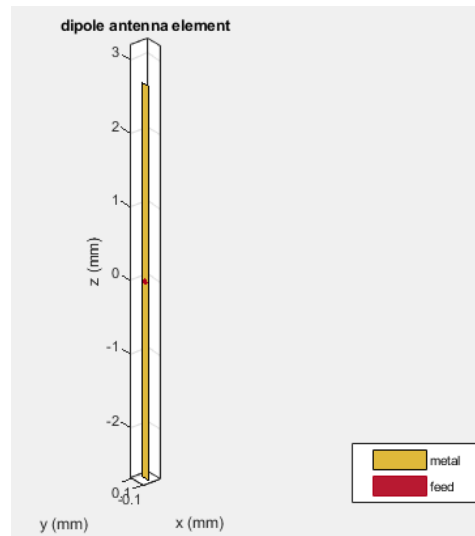

```
ant.show();
```

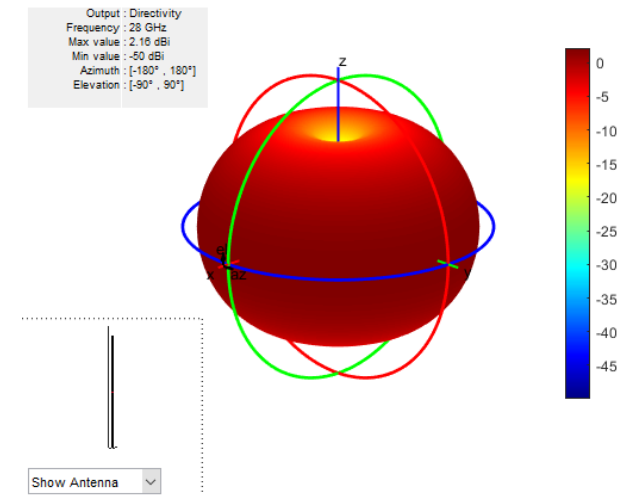

```
ant.pattern(fc)
```

Microstrip Patch Example

- ❑ A more complex antenna
- ❑ Many other parameters
 - Substrate selection (e.g. FR4, Rogers)
 - Shapes, notches, ...

```
%% Create a patch element
len = 0.49*lambda;
groundPlaneLen = lambda;
ant2 = patchMicrostrip(...
    'Length', len, 'Width', 1.5*len, ...
    'GroundPlaneLength', groundPlaneLen, ...
    'GroundPlaneWidth', groundPlaneLen, ...
    'Height', 0.01*lambda, ...
    'FeedOffset', [0.25*len 0]);

%%
% Tilt the element so that the maximum energy is in the x-axis
ant2.Tilt = 90;
ant2.TiltAxis = [0 1 0];

% Display the antenna pattern after rotation
ant2.pattern(fc);
```

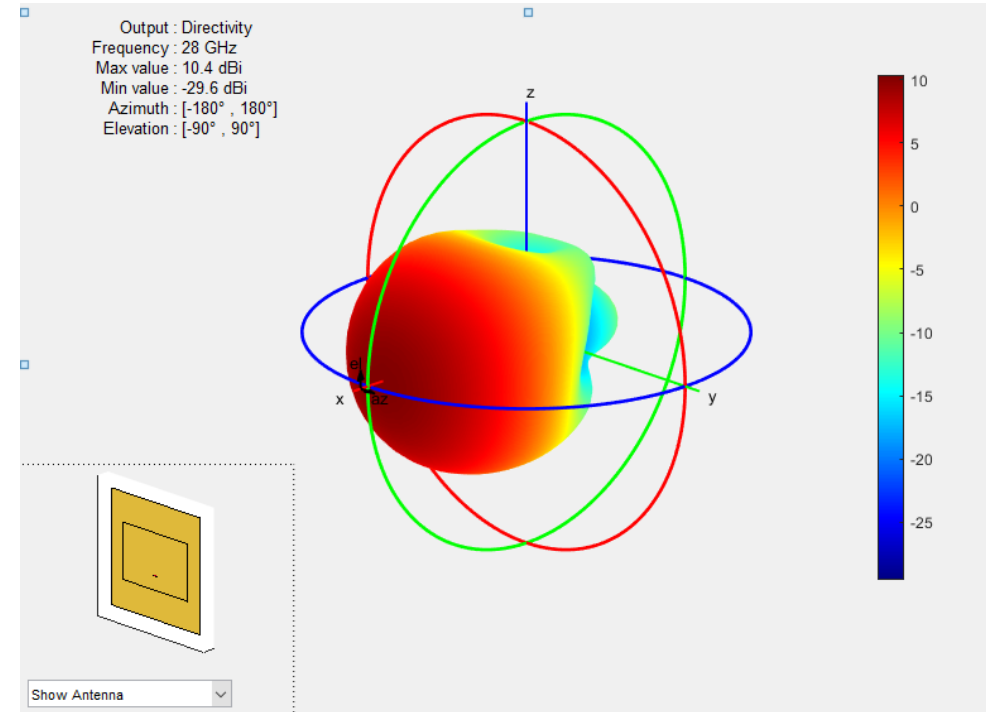

More Complex Antennas

- ❑ For complex antennas:
 - MATLAB antenna toolbox is often too slow
 - Cannot handle packaging, covers, obstacles, ...
 - Need other tools (e.g. Ansoft HFSS and CST)
- ❑ Use MATLAB custom antenna object
 - Store offline computed pattern

```
phasePattern = zeros(size(dir));  
ant3 = phased.CustomAntennaElement(...  
    'AzimuthAngles', az, 'ElevationAngles', el, ...  
    'MagnitudePattern', dir, ...  
    'PhasePattern', phasePattern);  
  
% Plot the antenna pattern.  
% Note the format is slightly different since we are using  
% the pattern routine from the phased array toolbox  
ant3.pattern(fc);
```

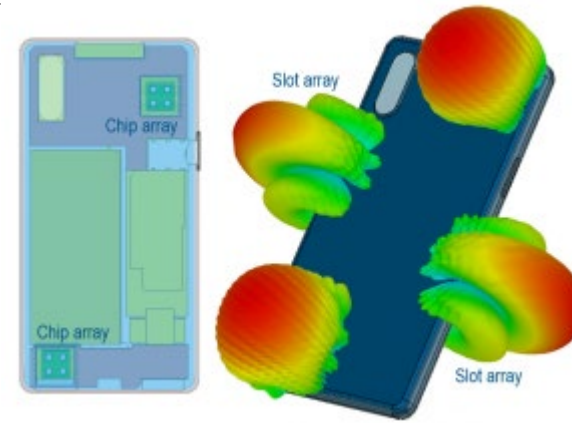

CST simulation of 28 GHz array on a handset with cover

<https://blogs.3ds.com/simulia/5g-antenna-design-mobile-phones/>

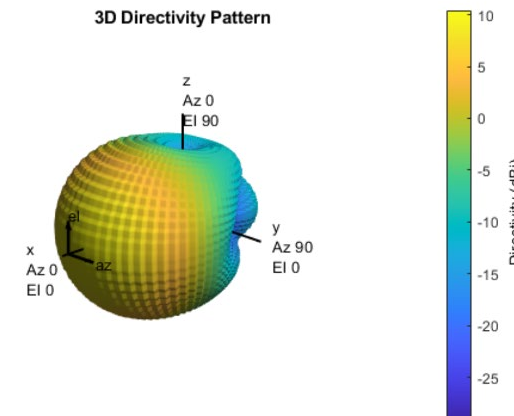

Demo of custom antenna element in MATLAB

Field Regions

- ❑ Antenna patterns depend on the region
- ❑ **Reactive near field:**
 - Reactive pattern dominates
- ❑ **Radiating near field** or Fresnel region:
 - Angular pattern depends on distance
- ❑ **Far field** or Fraunhofer region:
 - Angular pattern independent of distance
 - Radiation is approximately plane waves
- ❑ Can be approximately calculated using:
 - D : Maximum antenna dimension
 - λ : Wavelength

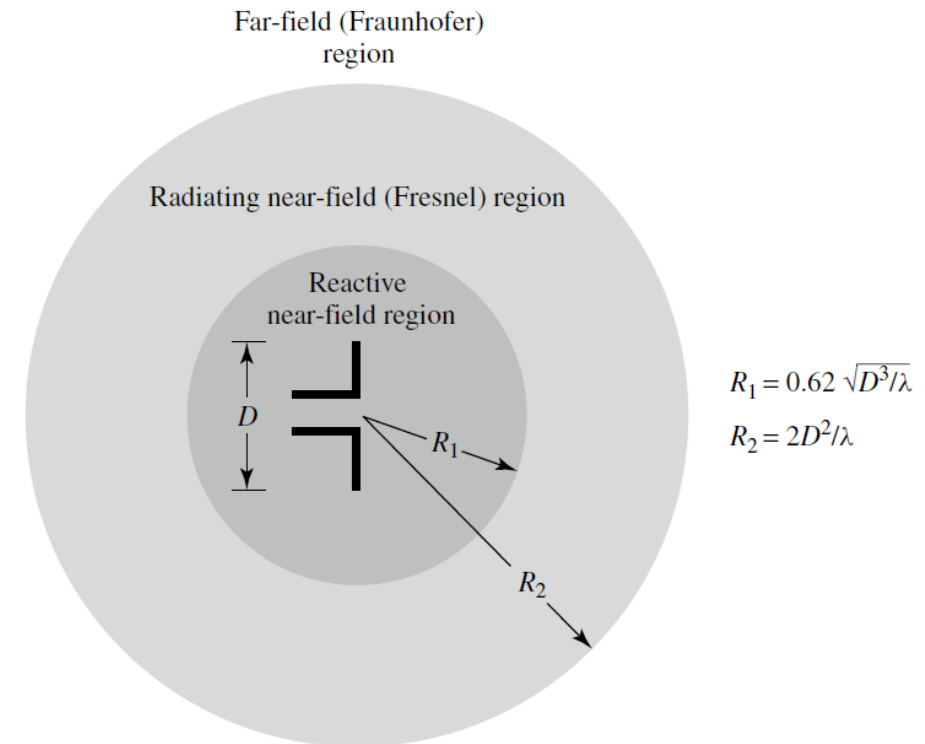

Rayleigh Distance

- Distance R_2 to far-field = Rayleigh distance
- Most cellular / WLAN systems operate in far field
- Ex 1: Half wavelength dipole antenna
 - $f_c = 2.3$ GHz:
 - $D = \frac{\lambda}{2}$, $R_2 = \frac{2D^2}{\lambda} = \frac{\lambda}{2} = 6.5$ cm
- Ex 2: Large cellular base station
 - $D \approx 7$ m, $f_c = 2.3$ GHz
 - $R_2 = 751$ m
- Ex 3: MmWave wide aperture antenna
 - $D \approx 40$ cm, $f_c = 140$ GHz
 - $R_2 = 149$ m

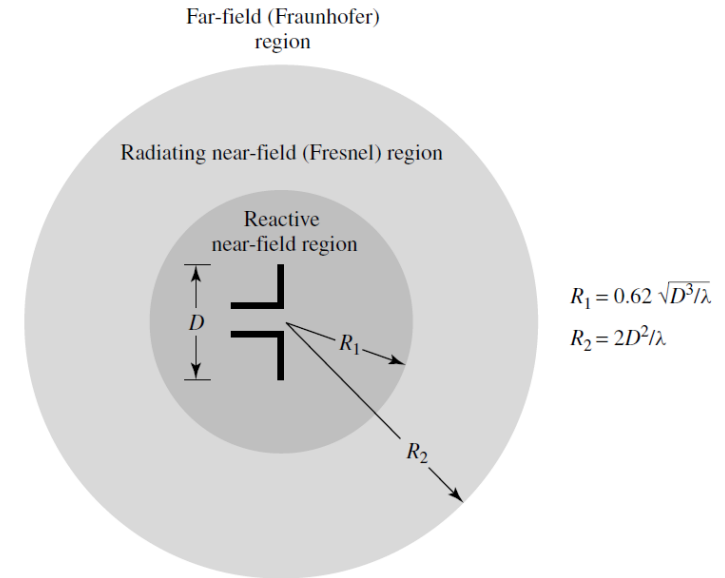

In-Class Exercise

Problem 3: Creating and Displaying a Patch Antenna

Create the patch antenna as follows:

```
% Compute the wavelength
fc = 28e9;
c=physconst('Lightspeed');
lambda = c/fc;

% Create the patch antenna
len = 0.49*lambda;
groundPlaneLen = lambda;
ant = patchMicrostrip(...
    'Length', len, 'Width', 1.5*len, ...
    'GroundPlaneLength', groundPlaneLen, ...
    'GroundPlaneWidth', groundPlaneLen, ...
    'Height', 0.01*lambda, ...
    'FeedOffset', [0.25*len 0]);
```

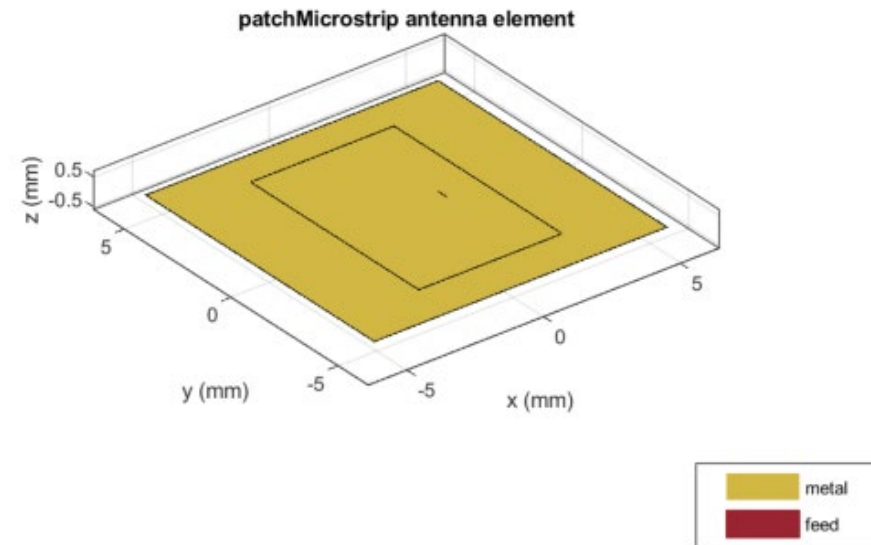

Outline

Basics of Electromagnetic Waves

Power and Bandwidth of Signals

Basics of Antennas

 Free Space Propagation

Antenna Effective Aperture

- Suppose RX antenna sees incident plane wave
 - Assume polarization aligned to the antenna

- The effective antenna aperture (or area):

$$A_e(\theta, \phi) = \frac{P_L}{W(\theta, \phi)} \quad [m^2]$$

- W = Power density of incident wave [W / m^2]
 - P_L = Power delivered to load at the receiver [W]
- The effective area that the antenna collects
 - We will see this is different than the physical aperture
 - A_e will depend on the direction of arrival

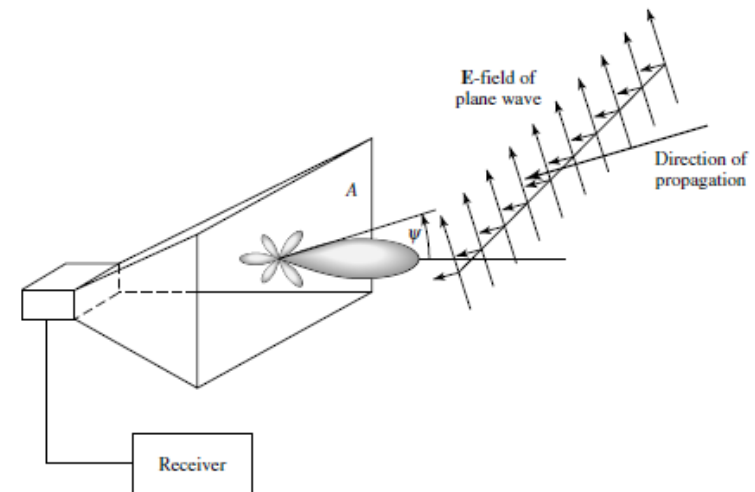

Aperture and Directivity

- From previous slide, effective aperture is: $A_e(\theta, \phi) = \frac{P_L}{W(\theta, \phi)} [m^2]$
 - Ratio of received power to incident radiation density

- Aperture-directivity relation:

$$A_e(\theta, \phi) = D(\theta, \phi) \frac{\lambda^2}{4\pi}$$

- True for all lossless antennas
- Proof: next slide

- Consequence: Average aperture is always $\frac{\lambda^2}{4\pi}$

- Why? $\frac{1}{4\pi} \iint A_e(\theta, \phi) \cos \theta d\theta d\phi = \frac{\lambda^2}{(4\pi)^2} \iint D(\theta, \phi) \cos \theta d\theta d\phi = \frac{\lambda^2}{4\pi}$

- Independent of the physical size of the antenna!

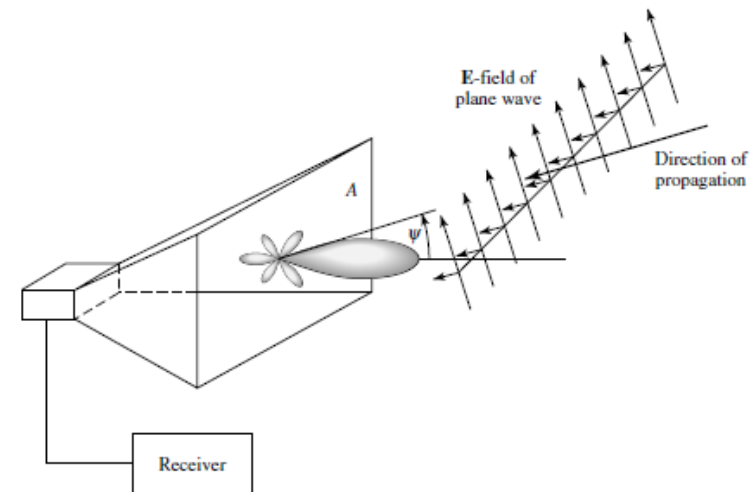

Reciprocity of Antennas

❑ To prove aperture-directivity, we need **reciprocity**

❑ Loosely stated:

Channel between antennas in both directions are equal

❑ Mathematically:

- If Ant 1 Transmits: RX voltage / TX current = $\frac{V_2^{oc}}{I_1}$
- If Ant 2 Transmits: RX voltage / TX current = $\frac{V_1^{oc}}{I_2}$
- Reciprocity: $\frac{V_2^{oc}}{I_1} = \frac{V_1^{oc}}{I_2}$

❑ Can show that with the same loads:

- Power transfer in both directions are equal: $\frac{P_{r2}}{P_{t1}} = \frac{P_{t2}}{P_{r1}}$

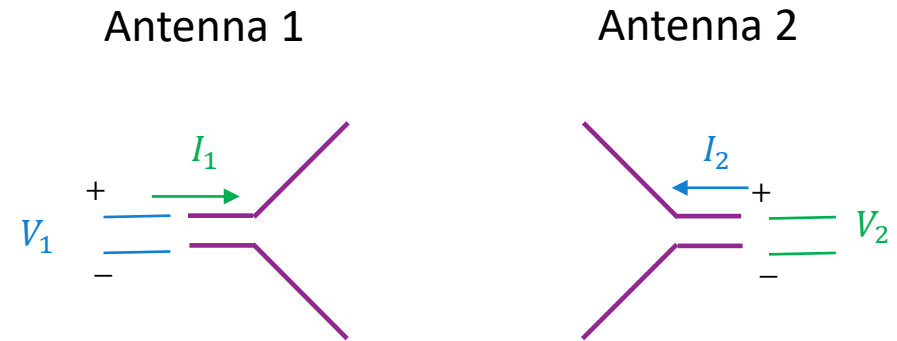

Proof of the Aperture-Directivity Relation

- Suppose Ant 1 transmits power P_t
- Radiation density is: $W = \frac{D_1 P_t}{4\pi R^2}$
- Received power at Ant 2: $P_r = A_2 W = \frac{A_2 D_1 P_t}{4\pi R^2} \Rightarrow \frac{P_r}{P_t} = \frac{A_2 D_1}{4\pi R^2}$
- TX from Ant 2, the gain must be the same: $\frac{P_r}{P_t} = \frac{A_1 D_2}{4\pi R^2}$
 - This is a consequence of **reciprocity**
- Hence, for *any* two antennas: $\frac{D_1}{A_1} = \frac{D_2}{A_2}$
- From simple antenna calculations for a short dipole:
 - $D_2 = \frac{3}{2}$, $A_2 = \frac{3\lambda^2}{8\pi} \Rightarrow \frac{D_2}{A_2} = \frac{4\pi}{\lambda^2}$ (Needs basic EM theory)

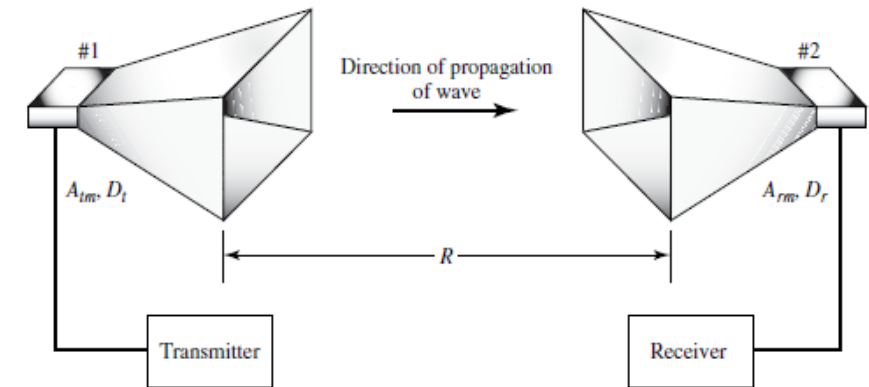

Friis' Law

□ Consider two lossless antennas in **free space**

□ From previous slide: $\frac{P_r}{P_t} = \frac{A_1 D_2}{4\pi R^2}$

□ From aperture-directivity relation: $A_1 = D_1 \frac{\lambda^2}{4\pi}$

□ This leads to **Friis' Law** (for lossless antennas):

$$\frac{P_r}{P_t} = D_1 D_2 \left(\frac{\lambda}{4\pi R} \right)^2$$

- **Path loss** is proportional to R^2
- Path loss Inversely proportional to $\lambda^2 \Rightarrow$ proportional to f_c^2

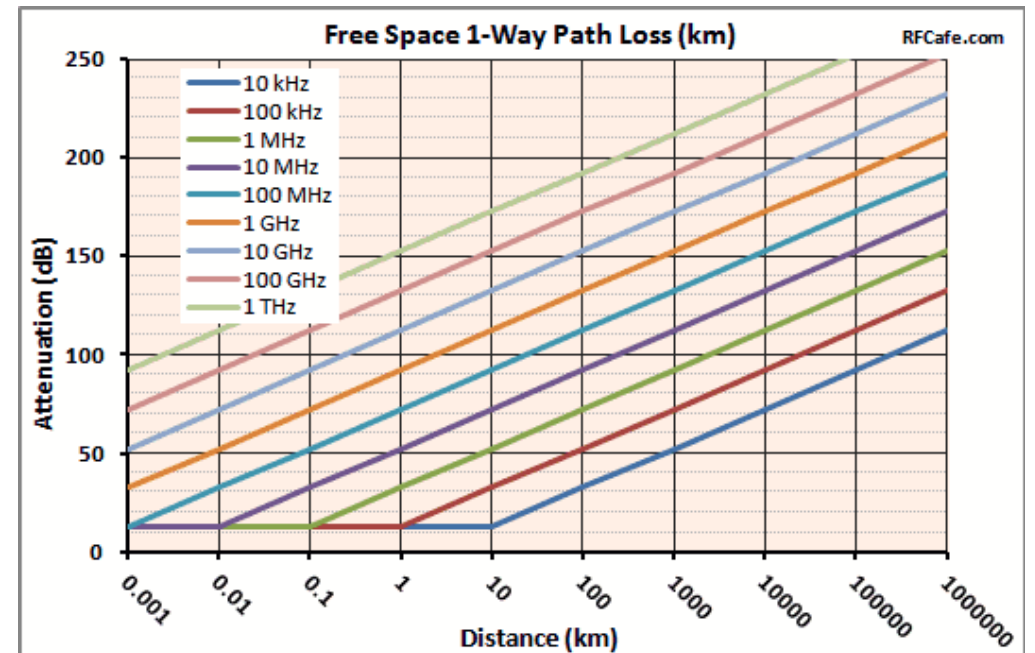

Example: Calculating Path Loss

- Suppose $f_c = 2.3$ GHz, $d = 500$ m, what is the **omni directional path loss**?
 - Omni-Directional path loss is path loss without the antenna gain
- This is easily done in MATLAB:

```
fc = 2.3e9;      % Carrier frequency
vp = physconst('lightspeed'); % speed of light
lambda = vp/fc; % wavelength

d = 500; % distance in meters

% We can compute the FSPL manually from Friis' law
% Note the minus sign
plOmni1 = -20*log10(lambda/4/pi/d);

% Or, we can use MATLAB's built in function:
plOmni2 = fspl(d, lambda);

fprintf(1,'Omni PL - manual: %7.2f\n', plOmni1);
fprintf(1,'Omni PL - MATLAB: %7.2f\n', plOmni2);
```

```
Omni PL - manual:    93.66
Omni PL - MATLAB:    93.66
```

Polarization Loss

- ❑ Friis' Law assumes incident wave is aligned in polarization
- ❑ In general, need to consider polarization loss
- ❑ Recall: **polarization vector** for a plane wave:
 - Direction of the E-field in phasor notation
 - A complex vector in 3-dim

❑ Polarization loss factor:

$$PLF = |\boldsymbol{\rho}_a \cdot \boldsymbol{\rho}_w|^2 = \cos^2 \psi_p$$

- $\boldsymbol{\rho}_a$: Polarization vector of the TX wave from antenna
- $\boldsymbol{\rho}_w$: Polarization vector of the RX incident wave
- ψ_p : Angle between them

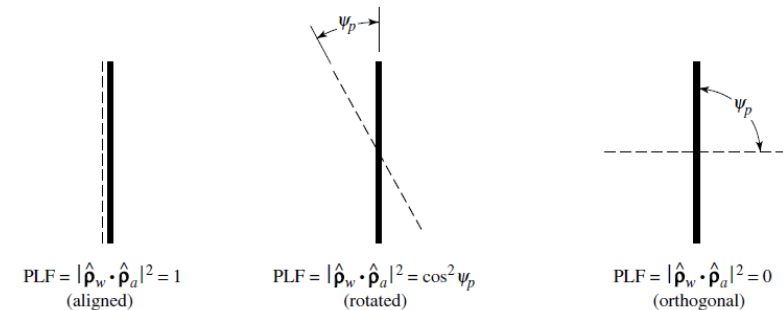
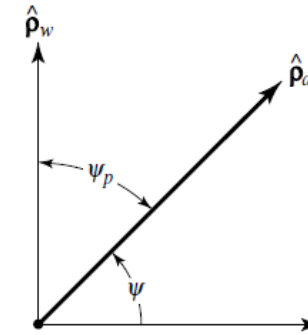

Example: Polarization Loss

Problem 1:

- Base station height 10m, V-polarized
- UE height 1.5m, “portrait mode”, V-polarized
- Ground distance = 50m
- What is the polarization loss in dB?

Solution:

- The E-field from the BS will be perpendicular to direction of motion
- Angle is $\cos \theta = \frac{d}{\sqrt{d^2 + \Delta h^2}} = \frac{50}{\sqrt{50^2 + 8.5^2}} = 0.985$
- Polarization loss is $10 \log_{10} \cos^2 \theta = -0.12 \text{ dB}$

Problem 2: What if the UE is turned to “landscape” mode?

- Now angle is $\cos \theta = \frac{\Delta h}{\sqrt{d^2 + \Delta h^2}} = \frac{8.5}{\sqrt{50^2 + 8.5^2}} = 0.168$
- Polarization loss is $10 \log_{10} \cos^2 \theta = -15.5 \text{ dB}$

Devices have to be able to received in multiple polarizations

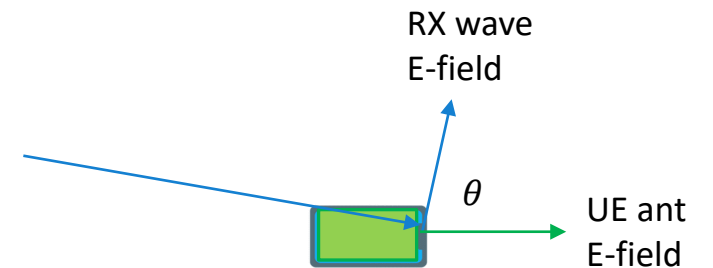
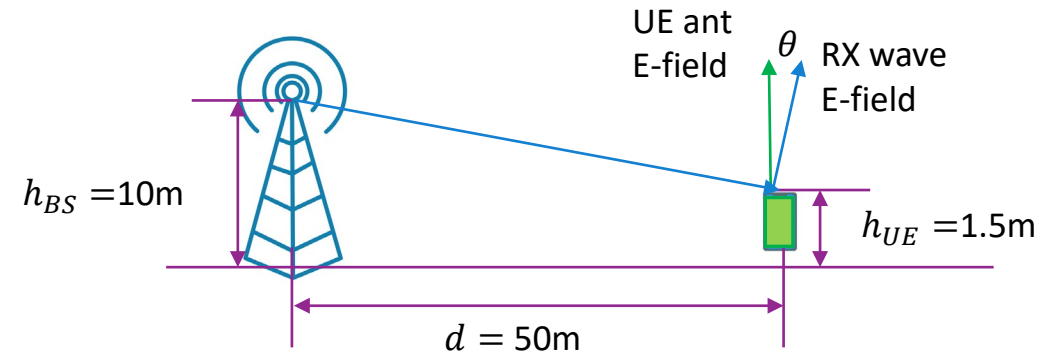

Antenna Impedance and Matching

❑ Not all power from radio may be delivered to antenna

❑ Some is reflected back

❑ Described by reflection coefficient Γ

- Also referred to as S_{11}
- Complex ratio of forward to reverse wave

❑ Also described by impedance mismatch:

- $\Gamma = \frac{Z_{in} - Z_0}{Z_{in} + Z_0}$

❑ Fraction of power transferred: $1 - |\Gamma|^2$

❑ Also given as voltage standing wave ratio (VSWR) $= \frac{1 + |\Gamma|}{1 - |\Gamma|}$

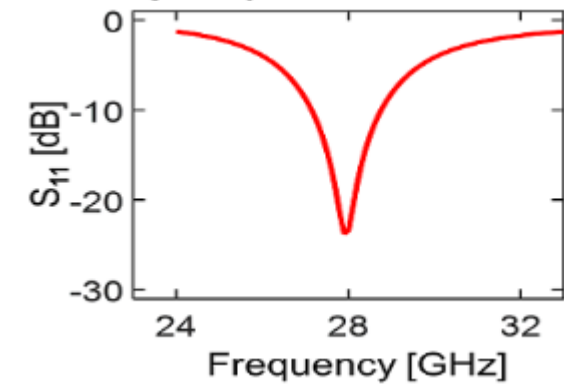
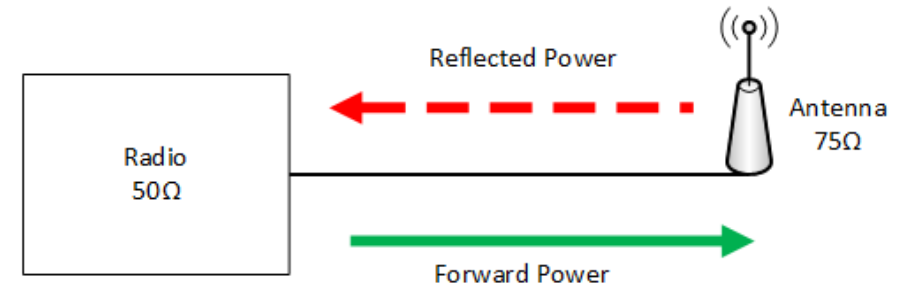

Ali et al, Small Form Factor PIFA Antenna Design at 28 GHz for 5G Applications, 2019

Friis' Law with Losses

Three losses in practice:

- Polarization loss
- Conductive / dielectric loss
- Impedance mismatch

Friis' Law with lossy antennas:

$$\frac{P_r}{P_t} = \epsilon_1 \epsilon_2 (1 - |\Gamma_1|^2)(1 - |\Gamma_2|^2) D_1 D_2 \left(\frac{\lambda}{4\pi R} \right)^2 \cos^2 \theta_{POL}$$

- ϵ_i : Efficiency of antenna
- θ_{POL} : Angle between the polarization vectors
- Note that gain is: $G_i = \epsilon_i D_i$

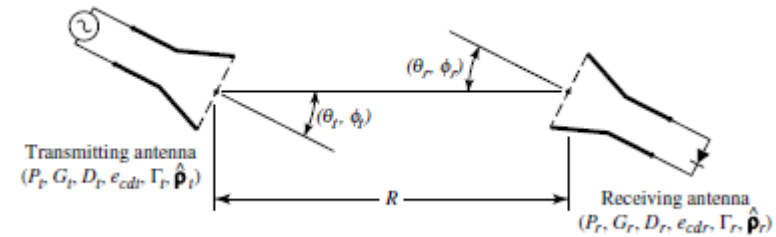

Demo: Plotting Path Loss on a Path

- ❑ Compute the path loss on a path
 - TX is isotropic at the origin
 - RX is micro-strip patch element. Moves along a line
- ❑ MATLAB code
 - Computes angles to RX
 - Computes free-space omni directional path loss
 - Interpolates directivity
 - Adds directivity to FSPL

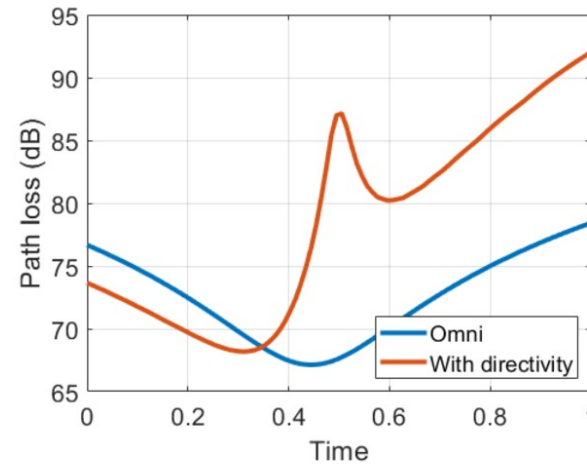
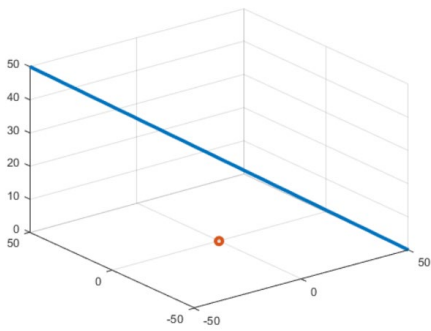

```
[azpath, elpath, dist] = cart2sph(X(1,:), X(2,:), X(3,:));  
azpath = rad2deg(azpath);  
elpath = rad2deg(elpath);
```

```
% Compute the free space path loss along the path without  
% the antenna gain. We can use MATLAB's built-in function  
plOmni = fspl(dist, lambda);
```

```
% Compute the directivity using interpolation of the pattern.  
% We can use the |ant3.resp| method for this purpose, but the  
% interpolation is not smooth. So, we will do this by hand using  
% MATLAB's interpolation objects.  
F = griddedInterpolant({el,az},dir);
```

```
% Compute the directivity using interpolation  
dirPath = F(elpath,azpath);
```

```
% Compute the total path loss including the directivity  
plDir = plOmni - dirPath;
```

```
% Plot the path loss over time. Can you explain the  
plot(t, [plOmni; plDir]', 'Linewidth', 3);  
grid();  
set(gca, 'FontSize', 16);  
legend('Omni', 'With directivity', 'Location', 'SouthEast');  
xlabel('Time');  
ylabel('Path loss (dB)');
```

In-Class Exercise

Problem 4: Plotting the Far Field Radiation Pattern

Use the `ant.pattern` command to get the pattern of the rotated antenna.

